

**Just
go**

Your Motorhome **Sidekick**



Your Essential Guide

Welcome to your motorhome sidekick manual. In this guide you will find guidance and tips to help you settle into your motorhome. At the back of the guide are some FAQ's and our contact details should you need them.

Please take the time to read this guide.

Keen to get your motorhome adventure started?

Keys

You have 2 keys on your coloured key ring fob:

- One for the ignition and diesel cap
- One for all the exterior lockers and habitation door
- Last 3 digits of your reg is displayed on the key fob

To avoid locking the keys in the motorhome always use the keys to lock the habitation door last when leaving.

Power

To connect the motorhome to mains electric you need to use the hook-up cable located in the gas locker. Plug this into the motorhome and the power supply as soon as you get to your pitch at the campsite to enable power to your motorhome.

Once you have arrived at your location try to position the motorhome on level ground. Un-wind the hook up cable fully from the reel to avoid overheating due to electric current.

Fridge

Fridge just needs to be turned on 1 star or Moon setting. Try to let the fridge cool before filling it with food and buy chilled food as this will help keep the food cooler.

**For Webasto under counter fridges use 1 light only*

Tip: These compressor fridges are super cool so turn off each night this will help conserve your leisure battery power especially if you are not on 240v hook up supply.

Gas on

If you do not have electric hook up then to enjoy the luxury of warm heating, hot water or to cook your favourite meal, you will need to make sure you have turned on the gas. To do this you need to go to your gas locker and turn the tap on the top of the bottle anti-clockwise. Please remember to turn the gas off at the bottle after you have finished using it. Keep the gas turned off when you are travelling, asleep and when the motorhome is left unattended.

Look out for the helpful 'find it sticker' which has been placed in your vehicle which is a quick guide to find various items on board.



Turning on heating & hot water

Please make sure you turn on your gas at bottle or you are hooked up to main supply at your campsite. Tap rotary push button to activate your screen.

Follow the below instructions in the order shown to get the best results. When you have finished using heating system it's important to make sure that you have turned off your Truma control panel before you turn off your gas / disconnect your electric supply.

Energy Source

Press rotary button once, turn rotary button two clicks to the right so you are selecting the energy setting, press to select, turn left for gas or right for electric then press once to confirm.

EL1 is for 6 amp sites (mostly in EU)

EL2 is for 10 amp sites (mostly in UK)

Important Note: Do not select 'Mix' option.

Room Temperature in C

Press rotary button once & then the motorhome symbol will flash, press rotary button to select this, turn rotary button to desired temperature and press once to confirm.

Fan Level

Press rotary button once, turn rotary 3 clicks to the right to the fan symbol, press once to select then adjust the fan setting to the desired level and press rotary button once to confirm.

Hot water

Press the rotary button once, turn rotary button one click to the right, press to select the hot water symbol, turn rotary button to select the desired temperature; Eco at 40c or hot 60c, press rotary button to confirm.

Important Note: Do not select the 'Boost' option.

Timer Set

We do not recommend that you use this feature.

Fault

See troubleshooting in the back of the sidekick manual or contact our 'On Road Support Team' during office hours.

Please contact the depot you collected the vehicle from.

Edinburgh Depot: +44 (0) 1525 878 006

Toddington Depot: +44 (0) 1525 878 005

Don't forget our handy video tour located on a USB stick - it can be found already in your TV

Control Panel

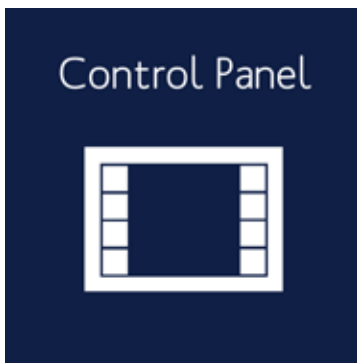

This appears when 240V supply is present.



This appears when motorhome is travelling and both batteries are coupled.



This appears when a fuse has blown.



1 Water Pump

Use for shower/sinks/toilet. Remember to turn off when not required.

2 External lights on/off

May not be present on your motorhome.

3 Internal lights on/off

This needs to be on for the TV to operate*.

4 Internal temperature

Press this once.

5 Water tank level

Press once for fresh water and twice for grey water.

6 Leisure Battery charge B2

Press this once to display voltage and twice to display remaining charge %.

7 Starter Battery charge B1

Press this once to display voltage and twice to display remaining charge %.

8 On/Off

Turns the control panel on or off. Make sure you turn off before leaving motorhome.

Depending on your model your control panel may look different but the icons will be the same.

NB. Always turn the control panel off when you leave the motorhome. Also ensure the water pump is off when not in use as it will empty all water from motorhome & burn out the pump if the frost protection switch trips.

LPG (Gas) Bottle

How to use and re-fill your LPG (Gas) bottle

Turning on

There are two types of tap, both of which you turn anti-clockwise to open, and clockwise to close.

The gauge only gives you a rough indication of the quantity of gas that is left in the bottle and this should not be relied on as an accurate measure of gas left.

The black line will indicate the level of gas. If you cannot fill the bottle up then this is more often than not that the bottle is full.



As a rough guide, a full bottle will last as follows;

Summer 2 berth 10-14 days, 4-6 berth 7-10 days
Winter 2 berth 7 days, 4-6 berth 5 days



NB. Make sure tap is closed when vehicle is moving, unattended or when you are sleeping.

Re-filling and returning full

- 1 Make sure the tap on the bottle is closed (turned clockwise).
- 2 Remove filler cap (turn anti-clockwise).
- 3 Put pump nozzle handle into Gaslow point and twist (bayonet fitting).
- 4 Squeeze nozzle handle and lock in open position.
- 5 Push and hold flow button on LPG pump.
- 6 Pump will automatically stop when full.
- 7 Release filler nozzle (it will make a whoosh sound).

When re-filling in Europe, use adaptors attached to the bottle, find the correct one and screw in firmly to the filler nozzle.

Please be aware there are very few filling points in Spain. EU filling locations can be found at: www.mylpg.eu



Please return full (unless pre-paid fuel package has been taken out prior to collection)

Please be aware there are very few filling points in North Scotland and Ireland.

Information about UK filling locations can be found at www.drivelpg.co.uk



Turning on heating & hot water

Turn on gas at bottle or connect to external power supply at campsite and turn on power in your motorhome. Tap rotary push button to activate your screen. Follow the below instructions in the order shown to get the best results. When you have finished using heating system it's important to make sure that you have turned off your Truma control panel before you turn off your gas / disconnected your electric supply.



Energy Source

1 Press rotary button once, turn rotary button two clicks to the right so you are selecting the energy setting, press to select, turn left for gas or right for electric then press once to confirm.

EL1 is for 6 amp sites (mostly in EU)

EL2 is for 10 amp sites (mostly in UK)

Note: Do not select 'Mix' option



Interior heating menu – temperature °C

2 Press rotary button once & then the motorhome symbol will flash, press rotary button to select this, turn rotary button to desired temperature and press once to confirm. Once confirmed top line symbol will flash when heating and will go solid once temperature has been reached



Fan level

3 Press rotary button once, turn rotary 3 clicks to the right to the fan symbol, press once to select then adjust the fan setting to the desired level and press rotary button once to confirm.



Hot water menu

4 Press the rotary button once, turn rotary button one click to the right, press to select the menu, turn rotary button to select the desired setting – ECO = water at 40C, HOT = water at 60C. Do not select BOOST. Then press rotary button once to confirm. Once confirmed the top line symbol will flash when heating and will go solid when temperature has been reached.

NOTE: The boiler heats the van first and then once temperature reached, switches over to heating the water. If you want hot water as a priority, turn off the interior heating so boiler only heats up the water and then turn on the van heating later.

Note

Above line = Setting selected
Below line = Selection menus



Timer Set

5 We do not recommend that you use this feature.



Fault

If fault code is not shown on screen, scroll down to triangle, press to select triangle, and fault code appears on screen. To clear fault see Troubleshooting / FAQ section

Window Sensor

(Fault Code 412)

The heating will not function if the window is open, close the window fully for it to work.

(Dependant on model, refer to the find it sticker)



NB. Never leave combi boiler on when vehicle is moving, unattended or when you are sleeping.

Troubleshooting

- 1 If your motorhome has a window switch, make sure the window it is fitted to is fully closed. Refer to your "Find it" sticker for the location if applicable for your model of motorhome.
- 2 If using gas as your power source for your heating ensure gas is on at bottle and isn't empty.
- 3 Ensure there is water in your fresh water tank.
- 4 Turn on the water pump on control panel.
- 5 Ensure leisure battery has charge if not on hookup.
- 6 Contact our on road support team if warning light persists. Please contact the depot you collected the vehicle from.

Edinburgh Depot: +44 (0) 1525 878 006
Toddington Depot: +44 (0) 1525 878 005

The general rule is a flashing code needs to wait 15 minutes until it stops flashing, and then once solid, press rotary knob twice to reset. E.g. 517 no gas

A code that appears on screen solid without flashing, needs fault correction in order to clear and restart boiler. E.g. 412 window open

If black triangle appears with no fault code, scroll down to triangle, press to select and code will appear on screen. See FAQs for regular codes and how to solve.



Frost protection switch

This is a safety device which releases your water to avoid burst pipes and boiler failure from freezing.

If you have refilled with freezing cold water and/or during colder months this button may pop out.

If you experience no water through the taps when you have fresh water in the tank and the water pump is turned on, loss of pressure or find water running underneath your motorhome it is likely that your frost protection switch has tripped. During the colder months this switch may pop out and automatically empty the water from the boiler to prevent it from freezing. (fig 1).

To reset the unit and restore normal functioning, the blue button **A** needs to be pressed in flush with the unit. The blue switch **B** on the top of the unit needs to be as pictured below. This is a manual override and should not be turned unless it is opposite to the below picture. Check the "find it" sticker in your motorhome to find the location of this switch.



If the blue button keeps popping out then the temperature inside and/or the water inside the tank is still too cold.

Don't panic, make sure you have water in your fresh water tank and put your heating on for a few minutes and then try to reset the button again.



Look out for this sticker which has been placed in the area that the device is located or alternatively please use the Find it sticker which will also point you to the correct location.

Using the stove

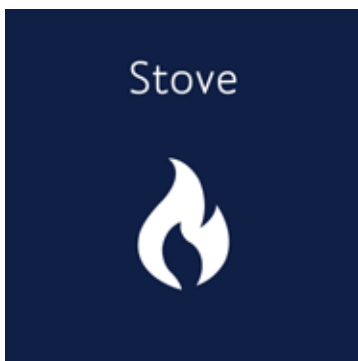

Using the stove

- 1 Turn on gas at bottle.
- 2 Turn and hold the relevant knob.
- 3 Keep knob depressed for 10-15 seconds then ignite.
- 4 Once ignited, flame size can be altered with the dial.



NB. Do not close the glass cover when the stove is still hot

Gas isolation taps



Stove

Oven

Boiler

Fridge

If you ever need to isolate the gas, check the "find it sticker" in your motorhome to locate these taps.

To isolate turn horizontal (on the image they are shown vertical). Contact the office so we can guide you through this.

NB. Dependant on the model of your motorhome you may have fewer taps because the fridge does not run on gas

Gas Oven & Grill

Thetford

- 1 Turn on gas at bottle.
- 2 Push in and turn dial to left for oven and right for grill, hold dial in for 10-15 seconds.
- 3 Press ignition button to light the gas.
- 4 Once ignited, oven temperature can be altered with the dial (gas mark).

Tip: remove the grill pan from oven whilst travelling to reduce noise

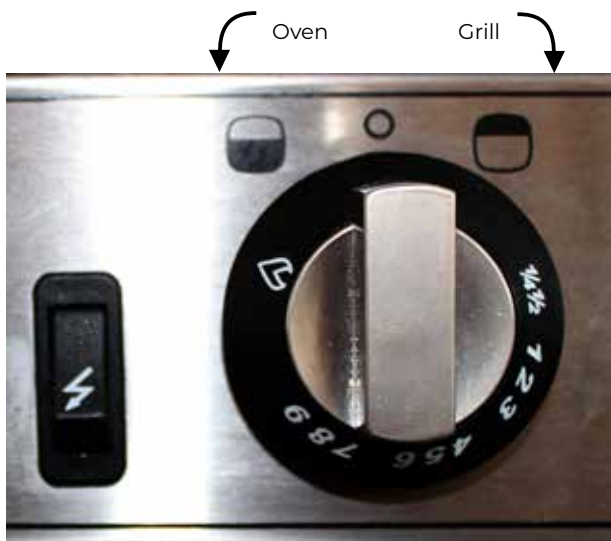

Fridge



The Thetford compressor fridge does draw a lot of electric power which is why to reduce consumption we advise to have the Moon button set. (not applicable to the Dometic model) and on the Webasto fridge to have this on 1 light setting.

If you are not on hook up, you should check your leisure battery level regularly on the Habitation panel. If it looks low, then to conserve battery power, we advise to turn off the fridge at night. The fridge will keep perfectly cool as the door is not being opened and closed.

Your fridge is a compressor type fridge which runs directly from the 12v leisure battery.

There are three makes of fridge used in our vehicles, and their operation is given below.

Thetford (tall upright fridge).

Press on/off button to operate. Press snowflake button to set temperature. If more than 1 blue light shows then keep pressing snowflake till only one blue light shows.

Then press Moon button to illuminate blue light.

To switch off, press on/off button till all blue lights disappear.



Dometic Isotherm (Fridge under counter & freezer recessed in worktop).

The fridge is switched on by turning the rotary thermostat dial, and then setting it to the desired temperature. To switch off simply rotate the thermostat dial to OFF. There is no ECO setting.



Webasto (under counter) fridge

Press on/off button to turn on. Five bright lights will show, because the door is open. To check the settings press the snowflake button and the dim lights will show. **We recommend you set it to 1 light.**

To change the settings, repeatedly press the snowflake button until the bottom dim light only is showing.

Note: Do not use ECO setting as this uses more power and may freeze the whole fridge.



Once the settings have been completed, if the door is kept open, the lights will change from dim lights to 5 bright lights. This is nothing to do with the settings changing but simply to help you see inside the fridge. When you next open the door the five bright lights will automatically show.



To switch off press the on/off button at the top and hold for approx. 5 seconds till all lights go out.

Toilet



Emptying the cassette

- 1 Unlock toilet cassette door with key and push both buttons in to open.
- 2 Lift blue lever and pull the cassette out using handle, see (fig 1).
- 3 Rotate grey arm straight and unscrew blue cap. see (fig 2).
- 4 Pour contents in a designated waste disposal area and rinse with water.
- 5 Use blue cap to measure 150mls of chemical and pour into grey arm then add up to 2 litres of water to mix. Then screw blue cap back on and return grey arm to original position.



Please remember there is a charge of £150 if you don't return it empty. There are no emptying facilities at Just go.

Using the toilet

- 1 Ensure vent to cassette is open when in use, and closed at all other times. This is controlled by the grey lever on the side of the toilet.
- 2 The seat swivels if required, and the water pump needs to be turned on from the control panel for the flush to function.
- 3 The **green** light behind the toilet will turn **orange/red** when the cassette is full.



We recommend that you don't wait till this light comes on as cassette can be quite heavy. Dependant on how many people are on-board we advise to empty every day or every other day.

You will need your water pump turned 'ON' on your control panel in order to flush.

Flush



NB. You will not be able to remove the cassette if the vent is open.

Dinette Table Bed Conversion

Basic principles for converting to a bed

- 1 The dining area converts into a bed. To convert it you need to lift off the table top (fig. 1) and press the button on the leg to fold (fig. 2).
- 2 Hook the table on the lower table support to form the base of the bed.
- 3 Take the seat cushions and place them on top of the base and use the rectangular cushion (stored in wardrobe) and place in the middle section.

For more leg space you can remove the back rest cushions

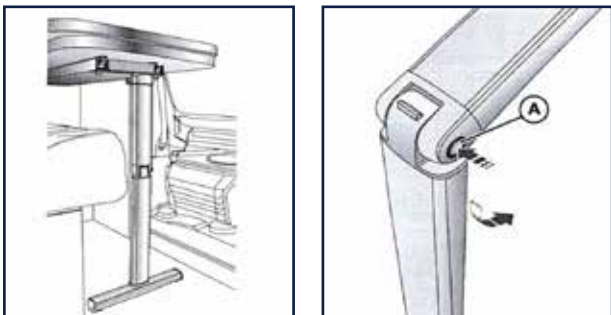

Dinette Area

Dinette Area Assembled



Extension Option 1

Extension Option 2



Extension option 1

These are stored in either the wardrobe or exterior lockers and slot into the holes into the base of the seating area. Pull the legs down to the floor.

Extension option 2

These pull out and the legs are lowered into place.

NB. The dinette side extensions are suitable for children only to sit on, and may break if sat on by adults.

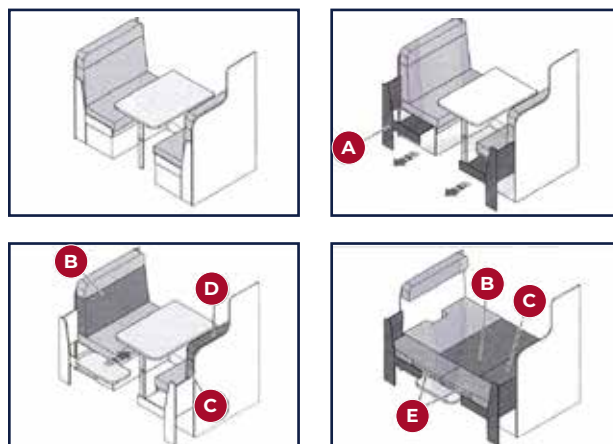

Enlarging the bed

- 4 Add table extension (stored inside cupboard or exterior locker) and lower the table by pressing the button on the leg. Remove backrest **B** and **C** and head rest **D**.
- 5 Position supplementary cushions **E**, back rests **B** and **C** and head rest **D** which must be positioned at the base of seat **C**.

If you do not have the panels which slide out then the extender boards will either be in your wardrobe or in your exterior locker.

U Shaped Lounge Bed Conversion



U Shaped Lounge Area (dependant on model)



Fully assembled bed



Enlarging the bed

- 1 Remove the left hand side seat cushion and back rest cushion to expose the bed frame.
- 2 Lift this up and over to fill the gap in the middle of the lounge area.
- 3 Use the long cushion found in the wardrobe to fill the gap.

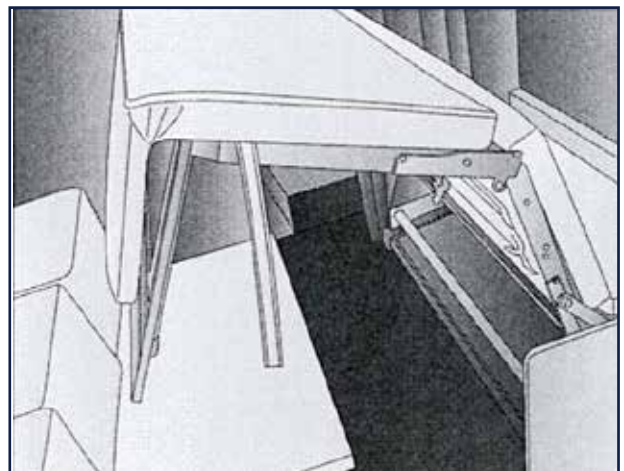
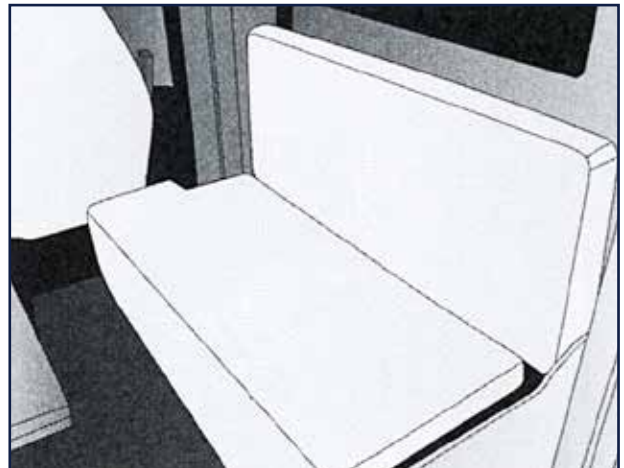

Place the remaining excess seat cushions underneath the bed for storage.

U Shaped Lounge Area (dependant on model)



Fully assembled bed (using existing cushions)



Fully assembled bed (using existing cushions)



Fully assembled bed (using additional stored cushions)

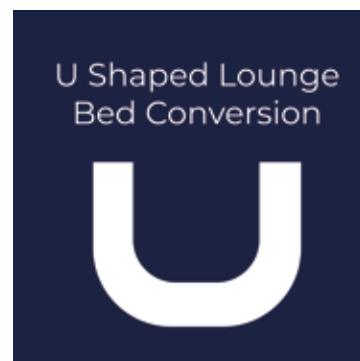

Converting to a bed

- 1 If you are using the portable table **A** first remove this and place back into the wardrobe.
- 2 Underneath the rear cushion **B** pull the wood slats out towards you, making sure you pull them out evenly **C**
- 3 Use the existing seat cushions to make the base of your bed **D E** then use the cushions in the under seat compartments to fill the remaining gaps **F G**

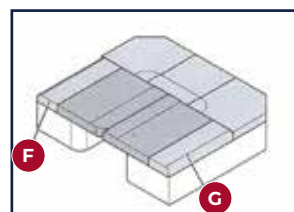
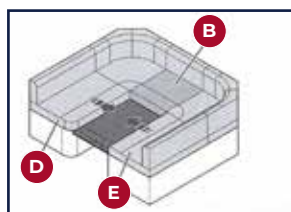
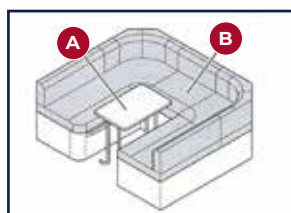

Place the remaining excess cushion/s underneath the bed for storage.

There are several ways to make up the bed by either using the existing cushions or by making it with the additional cushions instead.

You should be sleeping width ways to the motorhome.

Using the TV, USB & DVD System



The Remote



On / Off Button

Channel Selection

Source Selection

Tune Button

You may have to retune when you enter different counties or countries.

We cannot guarantee reception in some areas due to poor / weak signal strength

 To operate TV turn on internal lights 

Using the TV

- 1 Ensure lights are turned on via the control panel (same circuit as TV).
- 2 Ensure on/off rocker switch on the TV is on. Located either on the back panel of the TV or on the bottom of the screen surround.
- 3 Turn on TV using the red button at the top of the remote.
- 4 Hold down tune button (AQT).
- 5 Select the country you are in using the side arrows, then press OK (tuning can take up to 15 minutes).
- 6 A target region box will then appear; use arrow controls to select appropriate options then press OK.
- 7 Use channel selection button or guide button to browse channels.



Dependant on model either pull up or pull unit down

Push the silver lever up and pull unit towards you

Using the USB input / DVD player

- 1 Insert USB drive into the back of the TV or DVD into the slot on the right side of TV.
- 2 Use source button on remote to select USB or DVD (if it doesn't automatically play).
- 3 If using USB drive select desired video using left and right arrows, then press OK button to play.

Fitting Snow Chains

Fitting your snow chains

- 1 Unfold chain with red plastic end of cable towards the left.
- 2 Pass flexible cable around back of tyre, from left to right.
- 3 Pull the flexible cable up around the back of the tyre and fasten the steel ends together. Pull the chains around the front of the tyre.
- 4 Hook the outside flat green connector to the last link of the red end chain.
- 5 Pass the red chain into the red self-locking slide gear then hook on to the opposite side (if not possible fasten to another link).
- 6 After initial fitting drive a few metres, stop and check the snow chains for correct adjustment and positioning, incase it is necessary to re-adjust, tighten or improve upon the positioning.

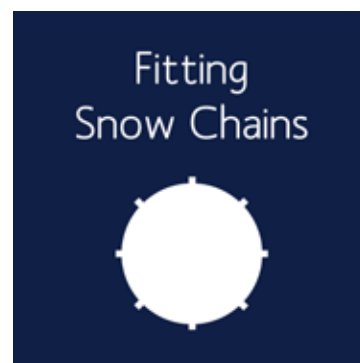

Removing

- 1 Unhook the red elastic tensioner and bring back through the slide gear.
- 2 Unfasten the cable at the red point.
- 3 Roll forward slightly to release the chain underneath the tyre.

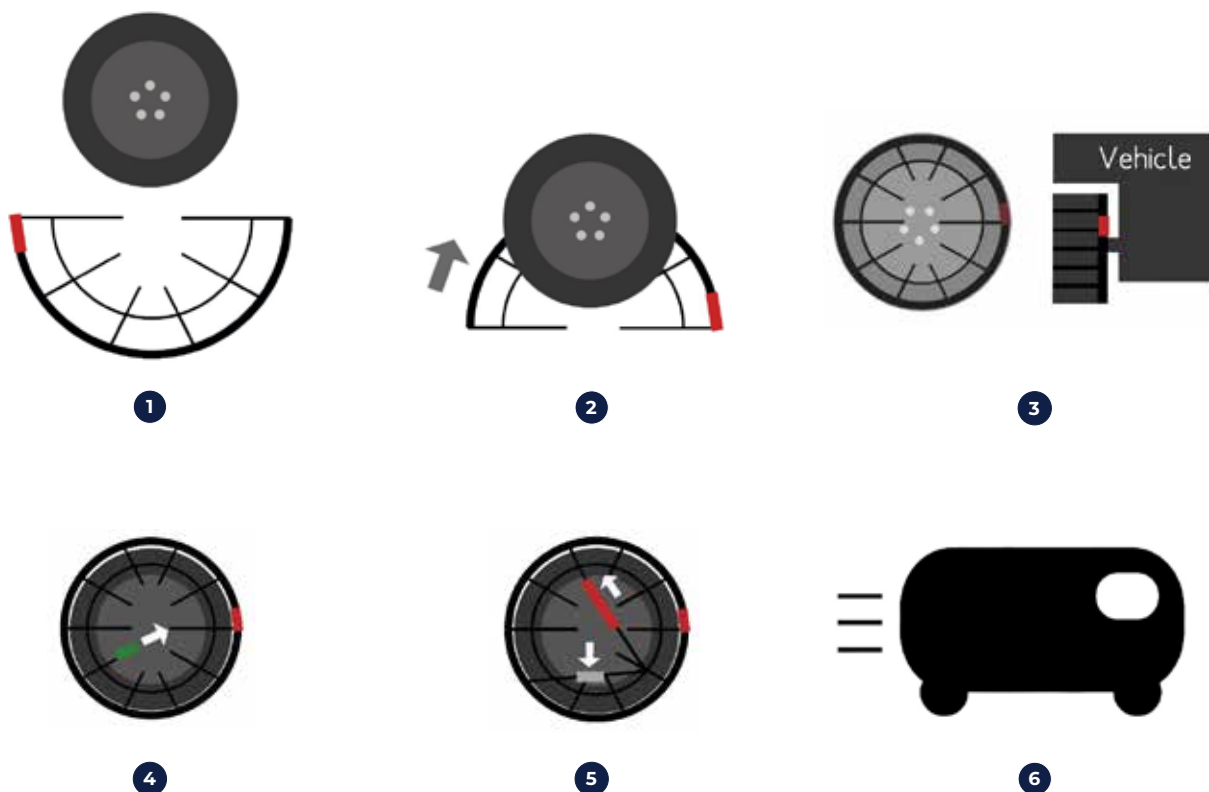

Always install the chains on the front wheels

Snow chains are for emergency use only; to get you out of trouble or danger. They are not designed for prolonged use and you should not exceed 30mph/50kmh

The Ford Dashboard



FORD Assistance
0800 111 234
0033 47217 2200



- A** Information display
- B** Speedometer
- C** Engine coolant temperature
- D** Fuel gauge
- E** Rev counter
- F** Automatic Transmission position indicator

	Air conditioning system		Do not open when hot		Engine warning lamp		Requires registered technician
	Air conditioning system lubricant type		Engine air filter		Glow plug indicator		Safety Alert
	Anti-lock braking system		Engine coolant		Interior luggage compartment release		See owners manual
	Avoid Smoking		Engine coolant temperature		Jack		Shield eyes
	Battery		Engine oil		Keep children out of reach		Stability control and traction
	Battery acid		Explosive gas		Lighting control		Stability control and traction OFF
	Brake fluid - non petroleum based		Fan warning		Air conditioning system lubricant type		Windscreen wash and wipe
	Braking system		Fasten seatbelt		Note operating instructions		Windscreen wiping control
	Cabin air filter		Flammable		Panic Alarm		Heated windscreen
	Side air bag		Front airbag		Passenger airbag deactivated		Low windscreen washer fluid
	Child safety door lock or unlock		Front fog lamps		Parking brake		Heated rear window
	Child seat lower anchor		Flue pump reset		Power steering fluid		Service engine soon
	Child seat tether anchor		Fuse compartment		Power windows front/rear		See service manual
	Child booster seat anchor		Hazard warning flashers		Power window lockout		Door ajar warning
	Leaving lane departure light		Hill descent control		Water in fuel warning light		AdBlue fault
	Tow Haul		Trail control		Lamps on indicator		Message centre indicator
	Cruise control		Direction indicators		Parking aid		Check fuel cap
	Low tyre pressure						

IMPORTANT: In the event of any red or amber warning lights staying on or flashing continuously please call Ford assistance in the first instance (number above), then please contact the depot you collected the vehicle from. Edinburgh Depot: +44 (0) 1525 878 006 or Toddington Depot: +44 (0) 1525 878 005



Left hand steering wheel controls



Right hand steering wheel controls



- A** Cruise control / Speed limiter controls
- B** Information display control menu
- C** Cancel button
- D** Reset button
- E** Cruise Control
- F** Speed limiter
- G** Back menu button

Resetting the Trip Computer use the right hand steering wheel controls **B**

Press and hold OK **B** on the trip screen to reset the respective trip, distance, time and average fuel consumption information

If you are set in a different screen and need to come out to perform the above then use the back menu button **G**

For the below functions use left hand steering wheel Controls **A**

Cruise Control – setting cruise speed

- 1 Press cruise control button **E**
- 2 Drive to desired speed
- 3 Press **SET +** or **SET -**
- 4 Take your foot off the accelerator pedal.

Changing the set speed

- 1 Press **SET+ or SET -** to change the set speed in small increments.
- 2 Press the accelerator or brake pedal until you reach the desired speed
- 3 Press and hold **SET+ or SET-** and release the control when desired speed is reached.

Cancelling the set speed

Push **CAN** button **C** or tap the brake pedal, the set speed does not erase

Resuming the set speed

Push **RES** button **D**

Switching cruise control off

Press **OFF** when the system is in the standby mode, or switch the ignition off

Speed Limiter

- 1 Press **F Set + or Set -**
- 2 Push the **RES** button **D** to set

Applying the parking brake (handbrake)

1. Firmly press the brake pedal
2. Pull the parking lever (handbrake) upwards to its fullest extent
3. Whilst the engine is on the red handbrake light will appear on the dash to confirm the handbrake is on.
4. Once set the parking lever (handbrake) will naturally fall back down into position.

Note: Do not press the release button while pulling the parking lever (handbrake) level upwards

Always fully apply the parking lever (handbrake) and make sure you shift the gear lever into Park position (P)

Releasing the parking brake (handbrake)

1. Firmly press the brake pedal
2. Pull the parking brake lever (handbrake) upward to its fullest extent.
3. Press the release button and push the brake lever (handbrake) downwards
4. Whilst the engine is on the red handbrake light will disappear on the dash to confirm the handbrake is off.

Parking Brake (handbrake) warning sound. This will sound if the parking lever (handbrake) has not been released fully and your vehicle is moving.

The Fiat Dashboard



- A** Speedometer
- B** Multifunction display
- C** Rev counter
- D** Engine coolant temperature
- E** Fuel level gauge with reserve warning light

FIAT Assistance
0161 332 1043
0044 161 332 1043

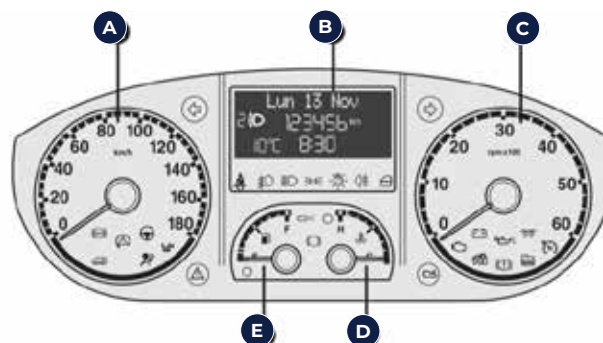

	Brake fluid Low (Red) / Handbrake engaged (red)		ESP-ASR system /traction plus failure(amber) - Hill holder failure (amber)
	Brake Pad Wear (amber)		Air Bag failure (red)
	Injection system failure (amber)		Self levelling suspension failure (red)
	Excessive engine coolant temperature (red)		Seat belts not fastened (red)
	Lefthand direction indicator (green intermittent)		Righthand direction indicator (green intermittent)
	Low Battery (red)		Front passenger air bag deactivated (amber)
	Cruise Control (green)		On constantly. Insufficient engine oil pressure (red) Flashing engine oil deteriorated (red) (multijet versions with DPP only)
	ABS System Failure(amber)		Power Steering failure (red)
	Incomplete doorload compartment closure (red)		Fuel Reserve (amber)
	Automatic transmission failure/ transmission oil maximum temperature (red)		EBD failure (red) (amber)
	glow plug heating/glow plug heating failure (amber)		Generic failure indication (amber)
	Fiat code protection system failure (amber)		Water in diesel filter (amber)
	Rear fog lights (amber)		External light failure (amber)
	Fog Lights (green)		Main beam (blue)
	Dipped Beam headlights (green) - Follow me home (green)		Parking sensor failure (amber)

Multifunction display control buttons

To scroll up through the screen and the related options or to increase the display value press UP.



Press MODE briefly to access the menu and/or to go to the next screen or confirm the desired menu selection

Hold down MODE to go back to the home screen.

Use DOWN to scroll down through the screen and the related options or to decrease the displayed value.

Speed Limiter Stalk

To activate the device, turn the ring nut **A** to bottom symbol.



Activation of the device is indicated by the symbol warning light. To store a speed value higher than displayed move stalk upwards (+) to desired speed value. To store a lower value than displayed move the stalk downwards (-) to decrease the value. To activate/deactivate the device press CANCEL button **B**.

Trip control button

Located on the stalk near the steering wheel, it can be used to set your mileage options on long journeys.



Cruise control

To switch on cruise control, turn the ring nut A to on (top symbol).

Cruise control cannot be used in 1st or reverse gear, we advise you to engage it in 4th gear or higher.

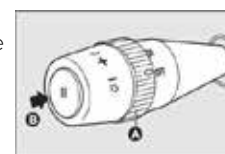

Storing vehicle speed

Turn ring nut A to ON and press accelerator until vehicle reaches desired speed, then move the stalk upwards (+) for at least one second then release.

IMPORTANT: In the event of any red or amber warning lights staying on or flashing continuously please call Fiat assistance in the first instance (number above), then please contact the depot you collected the vehicle from. Edinburgh Depot: +44 (0) 1525 878 006 or Toddington Depot: +44 (0) 1525 878 005

Returning your motorhome

We hope you have had an amazing time on your motorhome adventure and created some memories to treasure. Unfortunately, it is time to make your way back to us and return your motorhome.

For a quick and easy return, please make sure you do the following things:



1 Return on time

Your return time is marked on the rear view mirror hanger given to you and on your rental agreement & handover form signed upon collection.

Normal return time is between 8am and 10am. This is the window you have to hand your motorhome back so we can clean it for the next guests, so please return with plenty of time so you can unpack and we have time to check over your motorhome with you. Should there be any difficulties, please phone us as soon as possible as your motorhome will be going straight back out on hire.

2 Empty the toilet cassette & grey water tank at the last campsite visited

Please be aware that we do not have any toilet emptying facilities at Just go. Please ensure you return the toilet cassette completely empty. There is a fine of £150.00 if we have to do this for you.

3 Fill the LPG (GAS) tank

Your LPG gas needs to be returned completely full. Please try and fill up close to your last campsite the day before you return to Just go. Do not rely that the local filling stations close to the depot will have adequate supplies on the day of your return. Because of this we do have to pass on a charge if the gas tank is not full: £40.00 no matter how much gas is left.

4 Fill the diesel, fresh water & AdBlue* tanks (*Ford and 20 plate Fiats)

Please return the diesel, fresh water and AdBlue tanks completely full so that the next guests are ready to set off. If the diesel tank is not completely full and the diesel gauge is within the highlighted areas below, the following charges apply.



£140



£120



£90



£75

5 Remove rubbish, tidy motorhome & remember your belongings.

Whilst we don't expect it to be spotless, we do ask you to bring your motorhome back in a clean, tidy state with all rubbish removed. Please remember to take all your personal belongings with you when you leave the motorhome. If you do leave anything behind, we will let you know and return it to you as soon as possible.

We hope you had a thoroughly enjoyable trip and we would love to hear about it or see any photos of your trip away. Email us on joinin@justgo.uk.com



We love feedback and would be grateful if you would fill in a feedback form on your return. This helps us to continuously improve our services.

We are also grateful if you could leave us a review on Google.

Follow us on :

 Just go Motorhomes

 Just go Motorhomes

We look forward to welcoming you back very soon



General

- Pots, pans and cutlery can sometimes make a noise so pack items around them
- Take the grill pan out of the oven and store elsewhere or wrap in a tea towel
- Park on as level ground as possible
- Before each journey it is recommended to check the oil and water levels prior to long distance driving (see re-cap for oil type)

General road behaviour

- Please familiarise yourself with UK road signs and regulations. Always abide by the highway code: <https://www.highwaycodeuk.co.uk/>
- Use passing places to pull over to allow traffic behind you to pass, these are more common in Scotland & Cornwall
- Make sure you respect the speed limit and drive accordingly on motorways, built up areas etc
- Use your direction indicators where appropriate

Parking

- Check for height barriers at parking areas
- Check for signs in case motorhomes are not permitted
- Make sure that you read the rules which will be sign posted
- Pay and have your ticket clearly visible in the windscreen
- Pay for the appropriate allocated time
- Use appropriate larger spacing for larger vehicles, you are at risk if you occupy more than one space. Paying for 2 spaces is rarely accepted by the parking authority
- Use common sense do not obstruct driveways
- Do not park on private land
- Be aware of road markings
- Where possible use park and ride facilities to visit highly populated tourist areas where the roads may be unsuitable for a motorhome.

Reversing

- We do recommend that you take care and have someone outside to help guide you
- Do not rely on the reversing camera this is an aid only

Campsite

- Make sure that you tidy your pitch prior to leaving and you do not leave any items of rubbish.
- If you still have to check out at reception and pay site fees please do so prior to leaving, this is an agreement between you and the campsite.
- If you are leaving your pitch for a day out with the motorhome perhaps use a flag as a marker so you can easily identify your pitch upon return.

Fire precautions

- You have all the necessary safety measures inside the motorhome, familiarise yourself with these
- Be aware of your campsite fire meeting points and alarms

Wild camping

- Do not wild camp if the signs do not allow it.
- We do recommend you stop at campsites but if you find yourself wild/informal camping or camping off grid (festivals) the motorhomes are fairly self-sufficient but one item is purely charged by the leisure battery which is the fridge so check your leisure battery regularly and switch off your fridge at night to conserve battery power.
- When camping off grid, it is important to check the leisure battery voltage level on the control panel on a regular basis, and consider using a site with hook up every third or fourth night if possible.
- If you are free camping then be aware your plug sockets will not work as these do need 240v supply
- Make sure the ground is firm for parking
- The rule for wild camping is 'Take nothing but photographs. Leave nothing but footprints'

Protecting the environment

- Where possible use eco-friendly dog bags
- Use eco-friendly toilet chemicals
- Remove and dispose your rubbish in appropriate bins
- You must empty your toilet cassette at chemical disposal points, which will be clearly marked at campsites, any other location is an offence and if caught you will be given a hefty fine.

Pets

- If you are taking a pet you should have already advised Just go prior to collection and agreed to the pet policy
- Double check the campsite allow pets
- Most campsites do not object to well behaved pets but they should be kept well under control and on a lead at all times.
- Dogs must not be allowed to foul sites, roads or green areas.
- Carry a supply of disposable bags in your motorhome in order to clean up any mess made by your dog. Then dispose of it in an appropriate bin.

General Office Opening Hours

Summer: 2nd March – 31st October

Monday – Saturday: 08:00 – 17:00
Sundays Closed

Winter: 1st November – 1st March

Monday – Saturday 08:00 – 16:00
Sundays, Christmas & New Year Closed

Alternatively, you can send an email to:
enquiries@justgo.uk.com

Breakdown Assistance (For engine / Chassis Issues)

If you have a mechanical issue whilst out on the road please contact the relevant assistance line. Both Fiat & Ford offer a 24-hour service.

Fiat Assistance: 0161 332 1043 or 0044 161 332 1043

Ford Assistance: 0800 111 234 or 0033 472 172 200

Please be aware that any assistance call outs relating to a key locked inside the vehicle, incorrect or insufficient fuel, flat chassis battery or flat tyres that need to be towed will incur a charge that the hirer will need to cover.

Emergency text line

Should you have an emergency whilst out on hire then we have a text only service that you can use to contact a member of our team. The service is manned from when the office closes until 8pm Monday to Saturday and 9am – 12 midday on Sundays.

It is for Emergencies only so should your text message come in outside the manned hours or deemed a non-emergency a staff member may not get back to you until the office is next open.

Text: +44 (0) 7860 002 076

Please be aware that the staff member manning the emergency text line is not a key holder and is unable to open the office so please do not request to return your motorhome outside of the office hours.

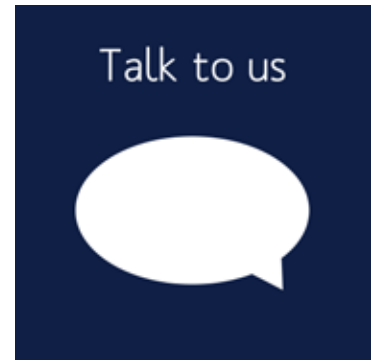

On Road Support team (during office hours)

If you need assistance with the vehicle whilst you are out, please feel free to contact our dedicated on road support team from 09:00 on the following numbers depending on which depot you collected from:

Please contact the depot you collected the vehicle from during the stated office hours

Edinburgh Depot: +44 (0) 1525 878 006.

Toddington Depot: +44 (0) 1525 878 005

Alternatively, you can send an email to:
onroadsupport@justgo.uk.com

Frequently Asked Questions



My Lights are not turning on.

Is the master light switch on the control panel switched on?

No Turn on the master light switch then you will be able to turn all lights on and off individually.

Yes (Move on)

Is the Leisure battery charged?

No You need to have power in your leisure battery to power the lights. Hook the motorhome up to the mains electric at your campsite to recharge the battery. The battery will also charge while you are driving.

Yes Give us a call at the office and a member of the Just go team will be happy to help you.

There is no water coming out of the taps.

Does the control panel show there is water in the tank?

No Fill tank with water using hose provided

Yes (Move on)

Is the water pump switched on?

No Turn on water pump on control panel, this pressurises the water around the system. Please make sure you turn the pump off when not in use to avoid burning the pump out

Yes (Move on)

Is the frost protection switch set?

No Push in the frost protection switch and refill the tank, make sure the pump is switched off. If the motorhome is too cold you may need to warm up the interior before you are able to reset the switch.

Yes Give us a call at the office and a member of the Just go team will be happy to help.

My 240v points are not working.

- Check the hook up cable is connected properly to the motorhome and the campsite power point.
- Check the power is on at the power point as not all campsites will include electric hook up as standard; you may need to pay to have the electric as an extra facility to your pitch. Alternatively, some power points may require you to switch them on first.
- Check the motorhomes RCD unit has not tripped. Use the 'Find It' sticker to locate the RCD unit which is normally found in one of your kitchen cupboards. This is a grey box with a black switch that can sometimes trip if the electrical system is overloaded. Make sure this switch is in the ON (up) position.

- Check the electric isolation key is in the ON position. This is the big red key found under one of the cab seats and when turned off will isolate all power to the motorhome. When the switch is ON it will be pushed in and to the right, when in the OFF position it will be out and to the left.
- Try plugging in and using another appliance as there may be a fault with either the appliance or item you are trying to use.
- If you are experiencing issue with the power, please contact our on road support team by contacting the depot you collected the vehicle from. Edinburgh Depot: +44 (0) 1525 878 006 or Toddington Depot: +44 (0) 1525 878 005.

There is water coming out underneath my motorhome.

- If there is water coming out from underneath the motorhomes this means the frost protection switch has tripped. The frost protection switch is there to avoid any damage to the boiler or pipes. When the weather is cold, the switch may trip and release all the water from the pipes underneath the motorhome.

If you have your water pump on when this trips it will continue to drain all water from your tank until there is none left and will eventually burn out the pump. Push the frost protection switch back in, refer to frost protection page for reference. Refill the tank making sure the water pump is switched off. If the motorhome is too cold you may need to warm the interior before you can reset the switch.

My Gas hob is not working.

Is the gas bottle switched on?

No Turn the gas bottle into the ON position

Yes (Move on)

Do you have enough gas in the bottle? Sometimes the gas bottle gauge can get stuck, give the bottle a good shake to see if the reading changes.

No Fill up with LPG gas at your nearest filling station.

Yes (Move on).

Is the isolation tap (located in the kitchen area) in the ON position.

No Turn the isolation key to the on position.

Yes Give us a call at the office and a member of the Just go team will be happy to help.

My fridge is not turning on.

Webasto (under counter) – open the fridge door. At the top of the control panel is a button with a circle and dot in the middle. Press and hold this button for about 3 seconds, and the setting lights will appear (dim lights) Once its on, if the door is kept open, the dim lights will change to bright lights, to help you see inside the fridge. This has nothing to do with the settings changing, and is normal for this make of fridge.

Thetford (tall upright fridge) At the top of the fridge is the control panel. The on/off button is the lowest of the three buttons. Press and hold till the blue light appears.

Dometic (under-counter) Rotate thermostat dial inside of fridge.

My fridge still won't turn on.

Are other 12 volts electrics working (such as water pump, lights etc). If not check the leisure battery reading on the Habitation panel. If the level is too low to power the 12v system, then either connect to 240v hook up to charge leisure battery or run the van engine to recharge the leisure battery. Also check the Habitation panel in case the Fuse Blown light is showing. If so then the fuse in the fuse box will need checking / changing. Please contact our on road support team by contacting the depot you collected the vehicle from. Edinburgh Depot: +44 (0) 1525 878 006 or Toddington Depot: +44 (0) 1525 878 005.

What setting should I have my fridge?

The Webasto should be on 1 star. To check this, press the snowflake button at the bottom of the control panel, and the dim lights will show the setting.

The Thetford should be on 1* Moon. Press the top button to check how many blue lights are lit and keep pressing until just one light is on. Then press the Moon button (middle button) to light up the moon setting.

The Dometic can be set to your preference and adjusted accordingly

My fridge is too cold and freezing the food.

Check you are on 1 star or moon setting. If so, then turn off the fridge at night, as the door is not being opened for access. The fridge will stay cool, and then if necessary turn it back on in the morning.

My fridge was working and has now switched off.

See the section above about ensuring the leisure battery has sufficient power.

My Webasto fridge is set on 1 star but keeps jumping up to 5 stars.

The five bright lights illuminate to let you see into the fridge when the door is open. They have nothing to do with the settings. If the bright lights are lit and you want to check the settings, then press the snowflake button and the dim lights will show you the settings. You can then make any adjustments to the settings using the snowflake button as described above. Once the changes have been made, if you keep the door open, the lights will go bright.

My boiler is not working, I can't get any heating or hot water working*?

Is the gas bottle switched on or are you hooked up to an external supply?

No If using gas - Turn the gas bottle into the ON position

No If using hook-up - Make sure you have connected the cable to external power supply point.

Yes (Move on)

Do you have enough gas in the bottle? Sometimes the gauge on the gas bottle can get stuck, give the bottle a good hard shake to see if the reading changes.

No Fill up with LPG gas at your nearest filling station

Yes (Move on)

Is there power to the external supply?

No Ask the campsite to switch on

Yes (Move on)

Is the window where the safety switch is located fully closed? (if applicable)

Error code 412

No Make sure the window is fully closed while using the boiler and the switch is fully depressed

Yes (Move on)

I have an error code appear and/or is flashing on my heating panel.

Error code 412

This means that the window with the safety switch is not fully closed.

Solution

The window is required to be fully closed.

Error code 407, 420 & 514

This means that there is no 240V power to the boiler.

Solution

Either connect your power cable to a 240V supply or change the power source to gas

Error code 17 / 401

This means the boiler reservoir is empty of water.

Solution

Check your frost protection switch and refill fresh water tank. Switch on pump to refill boiler

Error code 408, 507, 516, 517

These all mean that the gas supply has been interrupted.

Solution

The general rule is a flashing code needs to wait 15 minutes until it stops flashing, and then once solid, press rotary knob twice to reset. E.g. 517 no gas

A code that appears on screen solid without flashing, needs fault correction in order to clear and restart boiler. E.g. 412 window open

If black triangle appears with no fault code, scroll down to triangle, press to select and code will appear on screen.

See above for codes, if your error code is not listed please contact our on road support team by contacting the depot you collected the vehicle from. Edinburgh Depot: +44 (0) 1525 878 006 or Toddington Depot: +44 (0) 1525 878 005

My TV will not switch on.

Do you have the master light switch on the control panel switched on?

No Turn on the master light switch, this needs to be on to allow power through to the TV

Yes (Move on)

Is the leisure battery charged?

No You need to have power in your leisure battery to power the TV. Hook the motorhome up to the mains electric at your campsite to recharge the battery. The battery will also charge while you are driving (see there is no electric or power in my motorhome section)

Yes (Move on)

Are there batteries in the TV remote control?

No Try turning the TV on at the screen as the batteries may have run out of power

Yes (Move on)

Frequently Asked Questions



Do you have the master TV rocker switch turned on?

No Find the rocker on/off switch and turn on

Yes (Move on)

Are the connections & wires securely plugged into the TV?

No Make sure all wires and connections are plugged in securely

Yes Give us a call at the office and a member of the Just go team will be happy to help.

My TV will not tune in.

Do you have the master light switch on the control panel switched on?

No Turn on the master light switch, this needs to be on to allow power through to the TV

Yes (Move on).

Is the leisure battery charged?

No You need to have power in your leisure battery to power the TV. Hook the motorhome up to the mains electric at your campsite to recharge the battery. The battery will also charge while you are driving (see there is no electric or power in my motorhome section)

Yes (Move on)

Have you tried retuning the TV?

No The TV will need retuning every time you move into a different region or area.

Yes (Move on)

Is there a blue light on the white aerial box? If you follow the aerial wire you will find the location of the box.

No Check the white aerial box is turned on, there will be a separate on/off switch on the box.

Yes (Move on)

Is signal strength dial on the white aerial box turned up to full?

No Find the dial on the box which adjusts signal strength, ensure this is on full then try retuning the TV.

Yes You may be in an area where there is very poor signal, try asking other campers on the site if they are experiencing any problems. One last thing to check before giving us a call is if there is any noticeable damage to the aerial, if everything looks OK give us a call at the office and one of our team will help.

I can't remove the toilet cassette from the locker.

Is the grey lever on the toilet inside the bathroom closed?

No This lever needs to be in the closed position before you will be able to remove the cassette.

Yes Make sure you are also lifting the blue lever on the cassette up when trying to remove it. If you are still experiencing problems give us a call at the office and a member of the Just go team will help.

Dashboard warning light.

All of our motorhomes are well maintained and are serviced regularly however if a warning light appears on your dashboard, pull over as soon as it is safe to do so and refer back to the Fiat/Ford dashboard page. Alternatively, if you are also experiencing any loss of power or anything out of the ordinary feel free to contact Fiat/Ford assistance directly. The number can be found on the dashboard pages in this booklet and on a sticker on the windscreen. You just need to give the vehicle registration number when you call.

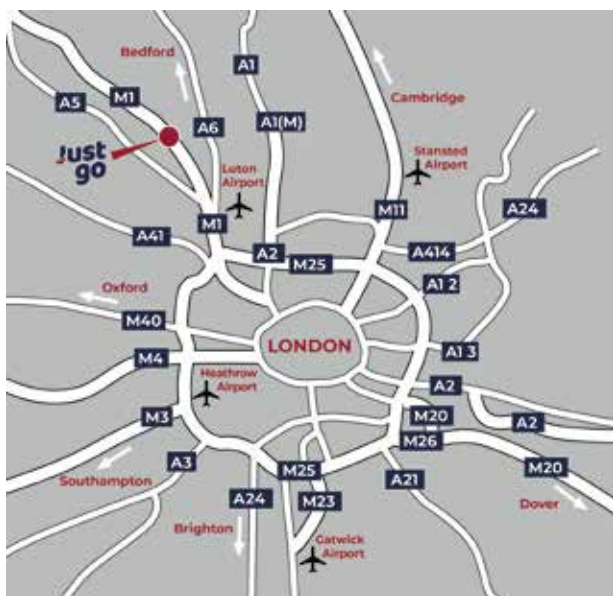

Greater London

Just go
Redhill Farm
Harlington Road
Toddington
Bedfordshire
LU5 6HF



Edinburgh Airport

Just go
2 Drovers Road
East Mains Industrial Estate
Broxburn
West Lothian
EH52 5ND



All information is correct at the time of printing and is subject to change without notice.

©Just go motorhomes 2021

The content displayed in this document is the intellectual property of Just go.

You may not reuse, republish, or reprint such content without our written consent.